



INSTALLATION AND SERVICE MANUAL

MINI-STAR™ ELECTRIC BOILER

Models 6MSE to 54MSE for Hydronic Heating
6 kW to 54 kW, 208 Vac to 600 Vac, Single or Three Phase

WARNING

Risk of electric shock. This unit may be connected to more than one electrical circuit. Turn off all electrical supply circuits before servicing.

IMPORTANT

- The boiler must be installed in accordance with all applicable national, provincial/state, and local codes, laws, regulations, and ordinances.
- This manual must be left with owner and should be located adjacent to the boiler for reference.
- Ensure boiler is full of water before turning on electricity. Elements will burn out immediately without water in the boiler.
- A boiler installed above radiation level (or as required by an Authority having jurisdiction) must be provided with a low-water cut-off device at the time of boiler installation.
- Overcurrent protection between the power supply and the boiler must be provided in accordance with the related national and/or local codes.
- Always ensure power is turned off before servicing.
- Electrical wiring or internal controls must be serviced by a qualified electrician. Any adjustment of the internal controls must be performed by a qualified service technician.

Post these instructions in a visible place.

DATE OF INSTALLATION :

INSTALLED BY :

PHONE :

Featuring the new
BC-1 Controller
with Outdoor Reset and DHW Override



Manufactured by
Allied Engineering Company
Division of E-Z-Rect Manufacturing Ltd.
Manufacturers of Gas and Electric Boilers, Stainless Steel Tanks, Tankless Coils, Electric Boosters
94 Riverside Drive, North Vancouver, B.C. V7H 2M6 • Telephone (604) 929-1214 • FAX (604) 929-5184
Branches: Calgary • Edmonton • Toronto



(OPTIONAL)



Dimensions and Specifications

Section 1

1.1 TECHNICAL SPECIFICATIONS

Maximum Operating Pressure: 90 p.s.i.
 Maximum Operating Water Temperature: 210°F
 Water Capacity in Boiler: 6.6 US Gallons
 Inlet and Outlet Pipe Size: 1 1/4" NPT
 Controller Pump Switch Capacity: 5A Maximum

Table 1: Super Hot MSE Series Electric Boiler Specifications. (Flange Type Elements)

Super Hot MSE Series Electric Boilers			Single Phase		Three Phase			
			208 Vac	240 Vac	208 Vac	240 Vac	480 Vac	600 Vac
Model	kW	Btu/Hr	Amp	Amp	Amp	Amp	Amp	Amp
6MSE	6	20,474	28.9	25.0	16.7	14.4	7.2	5.8
9MSE	9	30,708	43.3	37.5	25.0	21.6	10.8	8.7
12MSE	12	40,848	57.7	50.0	33.3	28.8	14.4	11.5
15MSE	15	51,185	72.1	62.5	41.6	36.0	18.0	14.4
18MSE	18	61,422	86.5	75.0	54.6*	47.3*	23.7*	18.9*
20MSE	20	68,240	96.2	84.3	63.6*	55.1*	27.6*	22.0*
24MSE	24	81,895	115	100	66.5	57.7	28.8	23.1
27MSE	27	92,124	130	113	74.9	64.9	32.4	26.0
30MSE	30	102,369	144	125	83.2	72.1	36.0	28.8
34MSE	34	116,008	164	142	100*	87.0*	43.5*	34.8*
38MSE	38	129,656	183	158	118*	102*	50.5*	40.4*
42MSE	42	143,304	202	175	116	101	50.5	40.4
45MSE	45	153,540	216	188	125	108	57.7*	46.2*
48MSE	48	163,776	231	200	138*	119*	59.6*	47.7*
54MSE	54	184,248	260	225	150	130	64.9	52.0

Note:

1. Other models of the MSE Series Electric Boiler may be available subject to inquiry.
2. * Delta connection (unbalanced load) amperage of high leg indicated.
3. Approximate shipping weights:

Model	Weight †
6MSE & 9MSE	114 lb
12MSE to 18MSE	116 lb
20MSE & 24MSE	118 lb
27MSE to 38MSE	122 lb
42MSE to 54MSE	126 lb

† Add 45 lb for package models



1.2 WATER TEMPERATURE RISE vs FLOW RATE

NOTE: The boiler should be properly sized for its heating application and maintain an adequate water flow rate during operation. Significantly oversizing the boiler or decreasing boiler water flow rate will cause excessive stage cycling and result in premature failure of the contactors.

Water flow rate vs temperature rise formulas in US gallons per minute (GPM) and liters per minute (LPM):

$$\text{GPM} = \frac{6.94 \times \text{kW}}{\text{Temp. Rise } (^\circ\text{F})} \qquad \text{LPM} = \frac{14.6 \times \text{kW}}{\text{Temp. Rise } (^\circ\text{C})}$$

Table 2: Water Temperature Rise vs Flow Rate in GPM (LPM)

Model	KW	10°F (5.6°C)	20°F (11°C)	30°F (17°C)	40°F (22°C)
6MSE	6	4.2 (16)	2.1 (8)	1.4 (5)	1.0 (4)
9MSE	9	6.2 (23)	3.1 (12)	2.1 (8)	1.6 (6)
12MSE	12	8.3 (31)	4.2 (16)	2.8 (10)	2.1 (8)
15MSE	15	10.4 (39)	5.2 (20)	3.5 (13)	2.6 (10)
18MSE	18	12.5 (47)	6.2 (24)	4.2 (15)	3.1 (12)
20MSE	20	13.9 (52)	6.9 (27)	4.6 (17)	3.5 (13)
24MSE	24	16.6 (63)	8.3 (32)	5.5 (21)	4.2 (16)
27MSE	27	18.7 (70)	9.4 (36)	6.2 (23)	4.7 (18)
30MSE	30	20.8 (78)	10.4 (40)	6.9 (26)	5.2 (20)
34MSE	34	23.6 (89)	11.8 (45)	7.9 (29)	5.9 (23)
38MSE	38	26.4 (99)	13.2 (50)	8.8 (33)	6.6 (25)
42MSE	42	29.1 (109)	14.6 (56)	9.7 (36)	7.3 (28)
45MSE	45	31.2 (117)	15.6 (60)	10.4 (39)	7.8 (30)
48MSE	48	33.3 (125)	16.6 (64)	11.1 (41)	8.3 (32)
54MSE	54	37.5 (141)	18.7 (72)	12.5 (46)	9.4 (36)

1.3 GENERAL DIMENSIONS

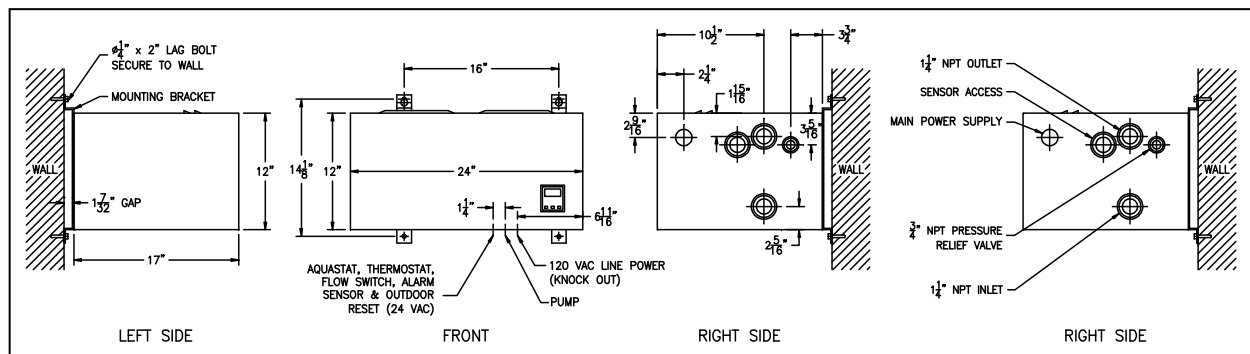

Figure 1 – General Dimensions



Installation Instructions	Section 2
----------------------------------	------------------

2.1 RECEIVING

INSPECT SHIPMENT FOR POSSIBLE DAMAGE. All goods are carefully manufactured, inspected, checked and packed by experienced workers. The manufacturer's responsibility ceases upon delivery of goods to the carrier in good condition. Any claims for damage, shortage in shipment or non-delivery must be filed immediately against the carrier by the consignee.

2.2 INTRODUCTION

The Super Hot Mini-Star Electric Boiler provides convenient and comfortable hydronic heating for closed loop systems in both residential and commercial applications. It is controlled by the BC-1 controller which regulates the boiler water temperature using three stages, switching stages on or off based on heating demand, PID (proportional, integral, differential) logic, and user-defined water temperature settings. The controller is capable of controlling a 120 Vac circulating pump (rated up to 5A or 600VA) which activates when there is a thermostat or DHW call for heat.

Using three stages to regulate the boiler water temperature has advantages over conventional on/off single stage boilers. Instead of switching all heating elements on or off using sequencers, the BC-1 controls each stage directly to minimize temperature fluctuations, avoid surges in line current, and reduce the number of on/off operations of the contactors and heating elements. Because the average "on/off cycle" of each of the heating elements is greatly decreased, this ensures better temperature stability, extends the life of the components and increases energy efficiency.

With the addition of an Outdoor Sensor to the BC-1 controller, "Outdoor Reset" can be used to increase or decrease outlet water temperature based on changing outdoor air temperatures. This feature helps reduce temperature swings and allows the boiler output to more closely match the actual heating load.

2.3 BOILER LOCATION

The boiler is intended for indoor installation only and must not be subjected to water spray or leakage. It may be installed in an enclosed space and attached directly to a combustible surface. Allow ample space around the boiler to ensure all connections and controls are readily accessible. The minimum required clearances for service are shown in the following table:

Minimum Clearance	Provides service access for
left side = 18 inches (458 mm)	elements
right side = 12 inches (305 mm)	plumbing connections
front = 12 inches (305 mm)	electrical components and fuses
top = 10 inches (254 mm)	screws for front casing panel
bottom = 10 inches (254 mm)	screws for front casing panel

It may be preferable to locate the boiler close to the electrical supply panel.

Protection from Liquids

The controller and other components located within the control panel are sensitive to water and other liquids. Measures must be taken to fully protect components on the control panel from contact with liquids. This especially applies to overhead pipes which may leak, burst or drip condensate and cause damage.



2.6 SYSTEM OPERATING REQUIREMENTS

MSE series electric boilers are designed for use in closed loop hydronic systems and are not intended for open systems, such as domestic hot water and pools, where water is continually replenished. Operating the boiler in an open system will result in premature failure due to corrosion of the boiler. Electric boilers may be used to heat water in open systems indirectly by installing a heat exchanger, such as the *Super Hot C-coil* or *Indirect Tank*, to separate open and closed systems.

Avoid unnecessary replenishment of system water. It can allow oxygen to enter the system and cause serious corrosion problems. As well, minerals dissolved in the water supply will precipitate when heated, thus preferentially depositing in the boiler.

The use of oxygen barrier piping is strongly recommended to protect the system and its components from corrosion. Chemical inhibitors are not recommended as their improper use or maintenance can cause accelerated corrosion, and premature failure of the boiler tank and its components. If your system includes “non-oxygen barrier tubing”, please contact the factory of your heating professional for recommendations.

Corrosion is a preventable condition and therefore **failure due to corrosion is not covered by the Super Hot product warranty.**

MSE series electric boilers must always be used with forced system circulation.



Wiring **Section 3**

3.1 ELECTRICAL WIRING

All electrical wiring must be done in accordance with the Canadian Electrical Code, CSA C22.1 Part 1, and/or any local regulations and codes in Canada, or the National Electrical code, ANSI/NFPA 70 (latest edition) and/or any local regulations and codes in U.S.A.. Verify the nameplate rating and check the related codes to properly size conductors, switches and overcurrent protection. Several openings are provided on the right and bottom of the casing for different voltage connections. For wire connections refer to the wiring diagram sticker on the back of the boiler front casing panel.

WARNING – Risk of Electric Shock: Disconnect all electrical power before installation or service! All circuit breakers ahead of and at the boiler must be OFF. Remove the boiler front casing panel by removing the screws at the top and bottom.

a. Wiring on Controller

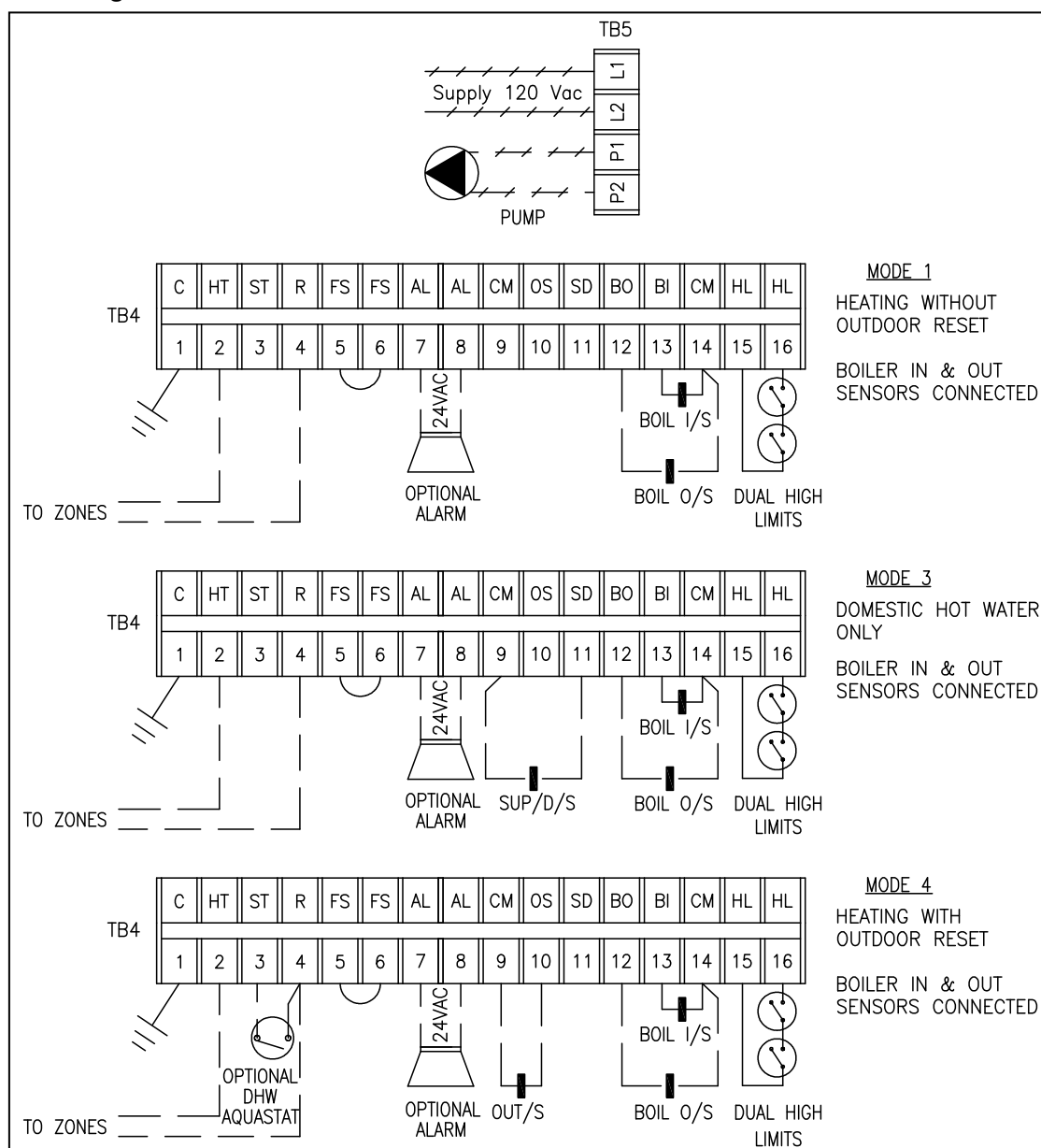

Figure 3 - Terminal blocks



Electrical Connections

For all electrical connections: Strip wire ends and insert into the terminal block. Tighten terminal screw clamps to securely hold the wire. **CAUTION - Risk of damage to the controller: Do not apply power to any connections on Terminal Block TB4 or TB5, except L1 & L2.**

Terminal Block	Connections	Name	Description / Comments
TB5	L1 & L2	Line Voltage	If L1 and L2 are not pre-wired, connect only 120 Vac, 60 Hz, single phase power to terminals L1 (Hot) and L2 (Neutral) of terminal block TB5.
	P1 & P2	Pump	Connect only 120 Vac, maximum 1/6 HP pump to terminals P1 and P2 of the terminal block TB5. If a pump horsepower larger than 1/6 HP is used, change the pump fuse on the boiler based on the pump rating. Do not use a pump requiring greater than 5A or 600 VA.
TB4	HL & HL	High Limits	Pre-wired (factory wiring). Two temperature high-limits (set at 239°F with automatic reset) are connected in series to terminals HL and HL.
	BO & CM	Boiler Outlet Sensor	Pre-wired (factory wiring). Connect outlet water temperature sensor to terminals BO and CM (common). The Boiler Outlet Sensor is inserted into the thermowell on the right side of the tank beside the boiler outlet.
	BI & CM	Boiler Inlet Sensor	Connect inlet water temperature sensor to terminals BI and CM (common). The Boiler Inlet Sensor is attached by cable tie to the boiler inlet pipe.
	OS & CM	Outdoor Sensor	Optional Outdoor Sensor (for Operation Mode 4 only): Connect Outdoor Sensor 070 to terminals OS and CM (common). The Outdoor Sensor is installed on an exterior wall, typically facing North, and above the snow line. It should be shielded from effects of heat or cold to prevent false outdoor temperature readings. Avoid direct sunlight, exhaust fans, appliance vents, and excessive moisture.
	SD & CM	Supply/DHW Sensor	Optional (for Operation Mode 3 only). Connect a Supply/DHW Sensor 071 to terminals SD and CM (common). The Supply/DHW sensor is inserted into a thermowell on the DHW tank or attached by cable tie to the supply pipe.
	AL & AL	Alarm	Optional. The alarm contacts are a powered output, do not apply power. Connect an alarm (beeper, light, or relay) with a rating of 24 Vac and maximum 0.45 A to terminals AL and AL.
	FS & FS	Flow Switch	Optional. Remove the jumper from the terminals FS and FS. Connect flow switch to terminals FS and FS. Do not apply power.
	ST & R	Setpoint DHW Demand	Optional Domestic Hot Water Aquastat (for Operation Mode 4 only): Connect domestic hot water aquastat to terminals ST and R. Closed is activation. Do not apply power.
	HT & R	Heat Demand	Connect Thermostat or Zone Valve End Switch to terminals HT and R. Closed is activation. Do not apply power.



b. Power Supply to Heaters

The supply cable has to be sized based on the amperage in Table 1 and the cables used.

Connect only specified line voltage and phase power to main terminal block on the control panel. Strip wire ends before inserting into terminal block. Tighten terminal screw clamps. Attach ground wire to ground terminal block on the control panel.

Startup Instructions

Section 4

4.1 WARNING

WARNING

The following instructions are intended as a guide for a Qualified Service Technician. Before switching the power on, fill the system with water and vent air. Check for and repair any leaks in the water piping.



4.2 STARTUP

a. Fill System

Figure 2 shows the suggested set-up for a make-up water supply using a pressure regulator (supplied with “PS” package). Do not apply full line make-up water pressure to the system. Fill the system to approximately 12 psi (cold water) if the expansion tank is pressurized at 12 psi. The expansion tank should be sized to provide the system with enough volume for thermal expansion and contraction while maintaining operating pressures within safe and reasonable limits. There should be no significant pressure fluctuations in systems having both an effective automatic fill valve and a properly sized expansion tank or expansion tank arrangement. The standard pressure relief valve supplied with the boiler is rated at 30 psi, or as required by order, but the maximum working pressure cannot exceed 90 psi for the electric boiler. Once the system is filled with water, all trapped air must be removed to avoid air locks, which can reduce flow rate and cause thermal shock. Figure 2 also illustrates the connections to the air purger (not supplied by manufacturer) and expansion tank in the line from the boiler to the radiation units. Additional air purgers should be installed at high points in the system to assist in removing air which can accumulate from the water supply line. All high points must be vented.

b. Startup Procedure

Perform the following procedure as a check for proper boiler and system operation:

1. Press and hold three keys found below the LCD screen of the controller until “Adjust” is displayed (Figure 3). In adjust mode, enter the desired settings for your heating application (see BC-1 Boiler Controller Manual for more information). (Note: This boiler is also equipped with a non-adjustable, high-limit temperature device set at 239°F as safety limit control. The high limit temperature device has an automatic reset function.)
2. Turn up all room thermostats above room temperature.
3. When power is supplied to the controller, the LCD displays “- - -”. When the thermostat calls for heat, the pump will be energized immediately and the pump indicator, , will display on the LCD. The “- - -” screen is replaced with the boiler target temperature. Next, the three stages are energized along with the stage indicator,  ¹²/₃₄, in sequence and based on the user settings. Once the boiler water temperature reaches the setpoint, the controller will regulate the boiler water temperature using the three stages. The number of stages that switch on is based on the heating demand and user settings. After all room thermostats are satisfied, the controller de-energizes the three stages, in sequence, and then switches off the pump.
4. Current must be checked by a qualified electrician at the feeder panel and compared to the values shown in Table 1.
5. Turn thermostats to the desired room temperature.



BC-1 Controller Information **Section 5**

WARNING

The following section is intended as a quick reference guide for the BC-1 Controller Manual. Read all instructions and the BC-1 Controller Manual before placing the boiler in operation or making any adjustments. Adjustments must be made by a qualified heating technician.

5.1 CONTROLLER INFORMATION

Control Board Dimensions:

4-3/4" (L) x 2-7/8" (W) x 1-7/8" (H).

Power Outputs:

Pump output from P1 P2 terminals on the pump terminal block is 120 Vac, 60 Hz, 5 A max. These terminals can provide an automatic on/off switching power supply to the boiler pump or a pump contactor. The load current of this output is limited by the pump fuse selected (boiler supplied with 3 A fuse) and must not exceed 5 A or 600 VA.

Boiler Stage outputs from Stg1&Stg1, Stg2&Stg2 and Stg3&Stg3 terminals are 24 Vac, 60 Hz.

Alarm output from AL&AL terminals is 24 Vac, 60 Hz, 0.45 A maximum.



Figure 4 – BC-1 Controller

Signal Inputs/Controls (Do not apply external power):

- HT&R:** Room thermostat or zone valve end switch, 24Vac switching input, closed is activation.
- ST&R:** Setpoint DHW aquastat, 24Vac switching input, closed is activation.
- FS&FS:** Flow switch, 24Vac switching input, closed is activation.
- HL&HL:** High Limits, 24Vac switching input, open at 239°F, automatic reset.

Thermistor Sensors

- BO&CM:** Boiler outlet sensor
- BI&CM:** Boiler inlet sensor
- OS&CM:** Outdoor sensor
- SD&CM:** Supply / DHW sensor



5.2 CONTROLLER DISPLAY

The BC1 uses a Liquid Crystal Display (LCD) as a method of supplying information. You use the LCD in order to setup and monitor the operation of your system. The BC-1 uses three push buttons (Item, ▲, ▼) for selecting and adjusting settings. As you program your control, record your settings for future reference.

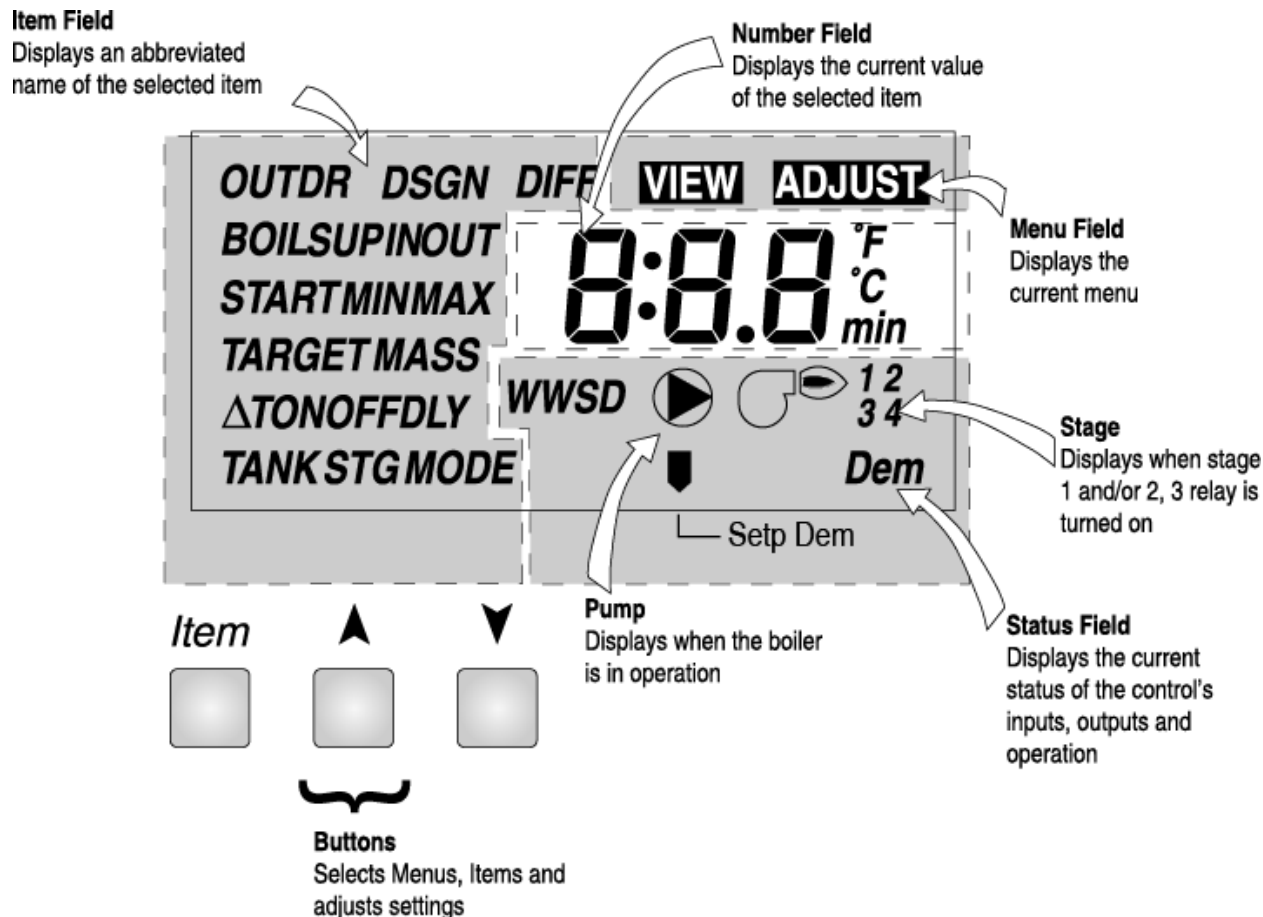

Figure 5 - BC1 Controller LCD Display

Menu

All of the items displayed by the control are organized into two menus. These menus are listed on the upper right hand side of the display (Menu Field). The default menu for the BC-1 is the View menu. While in the View menu, the VIEW segment is displayed. To select the Adjust menu, press and hold simultaneously all three buttons for 1 second. The display then advances to the Adjust menu and the ADJUST segment is turned on in the display. The display will automatically revert back to the View menu after 20 seconds of keypad inactivity. Once in a menu, there will be a group of items that can be viewed within that menu.

Item

The abbreviated name of the selected item will be displayed in the item field of the display. To view the next available item, press and release the Item button. Once you have reached the last available item in a menu, pressing and releasing the Item button will return the display to the first item in the selected menu.

Adjust

To make an adjustment to a setting in the control, begin by selecting the Adjust menu by pressing and holding simultaneously all three buttons. Then select the desired item using the Item button. Finally, use the ▲ or ▼ button to make the adjustment.



Summary of BC-1 Display Text in Installer Mode

VIEW MENU

Display Text	in Mode	Description
OUTDR	4,5	Outdoor air temperature measured by outdoor sensor
BOIL TARGET	1,2,3,4,5	Target boiler supply temperature the control is trying to maintain at the boiler supply sensor or the boiler outlet sensor
BOIL SUP	2,5	Current boiler supply water temperature as measured by the boiler supply sensor.
BOIL OUT	1,3,4,6	Current boiler outlet water temperature as measured by the boiler outlet sensor
BOIL IN	All	Current boiler inlet water temperature as measured by the boiler inlet sensor.
BOIL ΔT	All	Current T (temperature difference) between the boiler outlet sensor and the boiler inlet sensor
TANK	3	Current DHW tank temperature as measured by the DHW sensor.
BOIL ON	All	The total number of running hours of the boiler since this item was last cleared

ADJUST MENU

Display Text	Default	Description
MODE	1	Sets the operating mode for the control. The following modes are recommended for the Super Hot Electric Boiler: Mode 1 (parallel piping, setpoint heating); Mode 3 (parallel piping, dedicated DHW generation only), Mode 4 (parallel piping, outdoor reset with optional DHW override).
BOIL TARGET	180°F	Minimum boiler target temperature during reset override, setpoint or DHW operation.
TANK TARGET	140°F	Sets the DHW storage tank's temperature. Used in Mode 3 only.
TANK DIFF	5°F	Sets the differential for the DHW storage tank.
OUTDR START	70°F	The outdoor starting temperature used in the reset ratio for the heating system.
OUTDR DSGN	25°F	The design outdoor air temperature used in the heat loss calculations for the heating system.
BOIL START	70°F	The starting water temperature used in the reset ratio calculation for the heating system.
BOIL DSGN	180°F	The design water temperature used in the heat loss calculations for the heating system.
BOIL MAX	210°F	The maximum boiler target water temperature.
BOIL MASS	2	The thermal mass of the boiler used. Always use 2 for the Super Hot Electric Boiler.
DIFF	20°F	The differential that the control is to use when it is operating the boiler.
DLY	0:30 min	Determines when to stop purging the pump.
WWSD	70°F	The system's warm weather shut down.
°F / °C	°F	The units of measure that all of the temperatures are to be displayed in by the control.



5.3 CONTROLLER OPERATION

When the controller is powered, the controller enters the operating mode if there are no sensor or high limit errors present. The user should select one of the following modes from the controller adjust menu:

Mode 1 - Setpoint operation: Operates boiler stages to maintain fixed temperature at boiler outlet sensor when a heat demand is present.

Mode 3 - Dedicated DHW Generation: Operates boiler stages to maintain tank temperature at the SD sensor. An indirect hot water tank must be used.

Mode 4 - Outdoor reset with reset override: operates stages to maintain an outdoor reset temperature at the boiler outlet sensor. When there is a call for “reset override” from the DHW aquastat (i.e. ST&R is closed), the control operates the stages to maintain a setpoint temperature at the boiler outlet sensor. If both heat demand and setpoint DHW demand are present at the same time, the controller targets the higher of the two requirements.

When there is a heat demand or DHW demand the controller will switch on the system pump. If the sensor is not satisfied, the controller will switch on additional stage(s), in sequence, and based on PID (proportional, integral, derivative) logic. The controller continuously monitors the sensors and examines the difference between the target temperature and the sensor temperature. Depending on the difference in temperature (proportional), the time (integral), and how fast or slow the temperature is changing (derivative), it will determine when to switch a stage on or off. This feature prevents "short cycling", which can quickly wear out contactors and cause rapid temperature fluctuations.

The heating routine will operate until the water temperature reaches the user-defined temperature setting. Once reached, the control will automatically cycle the stage(s) of the boiler on or off, as necessary, to maintain the supply water temperature. The required number of stages which are activated is determined by the controller. After the call for heat has been satisfied, the stage(s) of the boiler will switch off, in sequence, followed by the pump.

5.4 RESET OVERRIDE

WARNING

If both Heat Demand and Setpoint DHW Demand are present at the same time, the controller targets the higher temperature of the two requirements. This may result in higher than intended water temperatures in either space heating loop or domestic hot water (DHW) heating loop. Use pipe rated for use at the highest possible water temperature.

The BC-1 Controller has one pump relay which is normally open and will closed (i.e. pump energized) when either a Heat Demand or Setpoint DHW Demand is present. When using Reset Override, a **switching external pump relay** (e.g. tekmar Relay 003) should be utilized to stop hot water flow to the space heating loop (e.g. radiant in-floor) and redirect it to the DHW heating loop during a Setpoint DHW Demand. See Figure 6 and Figure 7.

MODE 4 ONLY

(Outdoor reset and reset override)

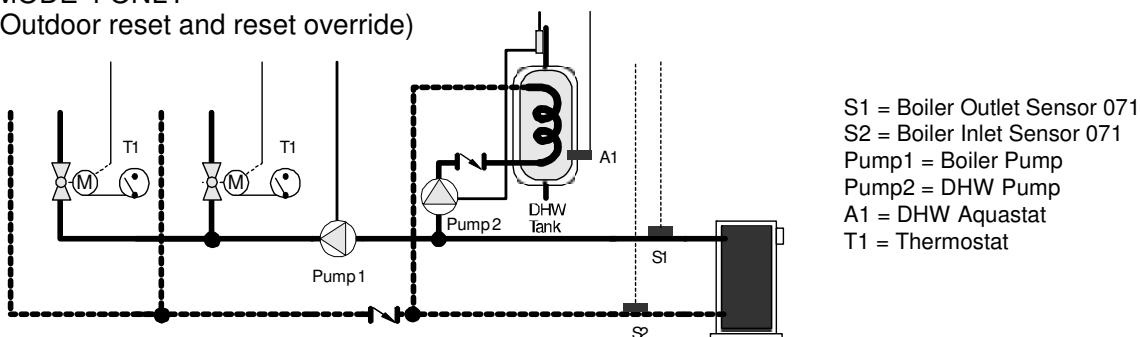

Figure 6 – Typical piping arrangement of system components in Mode 4



Sequence of Operation

Thermostat (T1) closed - Thermostat creates a Heat Demand resulting in a boiler target based on the outdoor reset settings. The boiler pump (Pump1) operates.

DHW Aquastat (A1) closed - DHW Aquastat creates Setpoint DHW Demand and activates external pump relay. The external pump relay causes the following actions:

- 1) Power for the boiler pump (Pump1) is broken. Pump1 does not operate.
- 2) Power for the DHW pump (Pump2) is made. Pump2 operates.
- 3) Setpoint DHW Demand creates a boiler target based on the higher requirement of the outdoor reset and reset override setting.

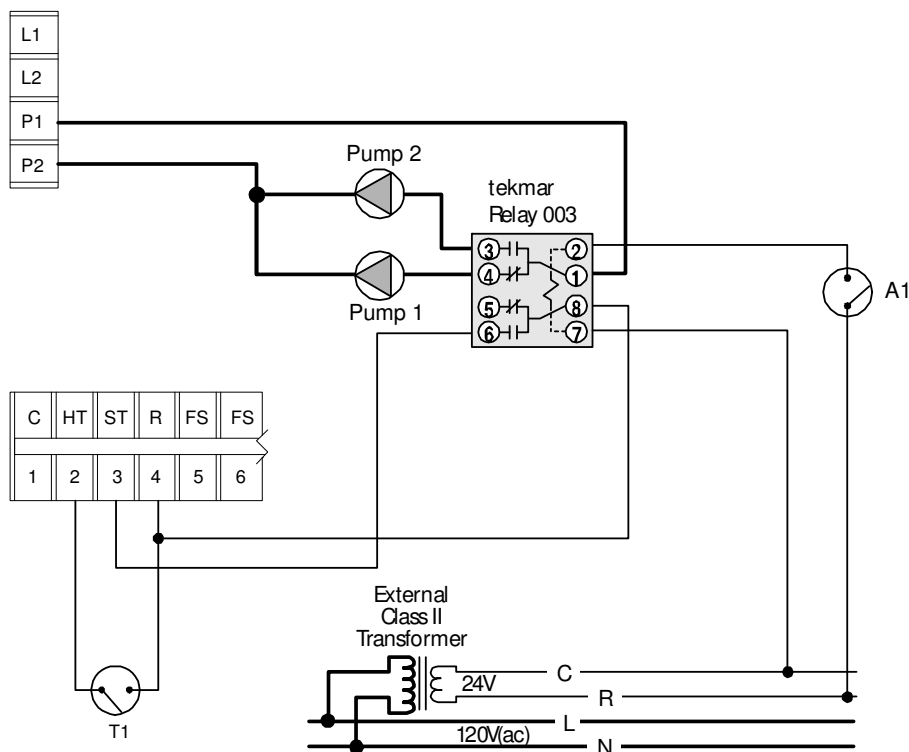

Figure 7 – Wiring diagram illustrating use of an External Relay to control pump operation

5.5 CONTROLLER MOUNTING

The BC-1 controller mounts on the controller mounting plate in the control chamber using a sheet metal screw. The LCD and buttons should be visible and accessible from the front of the boiler casing. To remove the controller: 1.) remove the front casing panel, 2.) pull off the black plastic top cover of the controller, 3.) unscrew the sheet metal screw, 4.) lift the controller slightly out of the rectangular cutout in the mounting plate, 5.) pull off the Molex connector while simultaneously holding down the tab on the left side.



Maintenance Instructions

Section 6

6.1 SERVICE HINTS

- a. This boiler has been designed to provide years of trouble free performance under normal operating conditions. However, the owner should conduct a general external examination at the beginning of each heating season and at mid-heating season to assure good working performance is continued. In addition, a qualified service technician should examine the boiler at least once every year.
- b. Do not store anything against the boiler or allow dirt or debris to accumulate in the area immediately surrounding the boiler.
- c. Elements will burn out if the boiler is not filled with water when electrical power is turned on. Do not connect thermostat wires until system has been filled with water. Water should be drained out from system only when absolutely necessary to make repairs or prevent freeze-up during extended cold weather shutdown.
- d. The pressure & temperature gauge on the system should be checked frequently. During normal operating conditions, pressure should be relatively stable throughout the heating season. If pressure under normal operating conditions consistently rises and falls over a period of time, this can indicate a fill valve leak, system leak or expansion tank malfunction. Leaks anywhere in the system must be repaired without delay. If any leaks or significant pressure fluctuations are observed, call for service immediately.



Troubleshooting Guide	Section 7
------------------------------	------------------

7.1 TROUBLESHOOTING – For Use of Licensed Electricians Only

WARNING

RISK OF ELECTROCUTION – HIGH VOLTAGE - ALWAYS SHUT OFF MAIN POWER TO THE ELEMENT HEATING CIRCUIT BEFORE TROUBLESHOOTING! Also, beware of 120V power while troubleshooting near the line-in terminals (L1&L2), pump terminals (P1&P2), transformer and pump fuse.

This section is meant to assist the service technician when troubleshooting the electric boiler. As in any troubleshooting procedure, it is important to isolate a problem as much as possible before proceeding. Carefully check all external and internal wiring following the wiring diagram sticker on the back of the boiler's door. An additional wiring diagram is enclosed with this manual. Often the controller error message (refer to the BC-1 Boiler Controller Manual) can be a great help in identifying the cause of a problem.

PROBLEM	CAUSE	SOLUTION / CHECK
BC-1 display is blank.	• Incorrect supply power.	• Check for 115V (AC) across L1 and L2.
	• Faulty transformer.	• Check for 24V (AC) across terminals C-1 and HL-16.
	• Faulty high limit switch.	• Check for open circuit between HL-15 and HL-16 and 24V (AC) across HL-16 and C-1.
	• Internal control fault.	• Replace controller.
BC-1 displays an error message.	• E01 – Controller unable to read from its EEPROM	• Verify all the settings in the adjust menu are correct.
	• Shr – Controller is unable to read from one of the sensors.	• Check for short circuit at the sensor which is displayed on the LCD.
	• OPn – Controller is unable to read from one of the sensors.	• Check for loose connection/open circuit at the sensor which is displayed on the LCD.
	• Defective sensor or controller.	• Perform "Sensor Check" described in Section 7.2 and replace if necessary.
No heat when called by thermostat and stages are <u>NOT</u> displayed on LCD screen.	• Thermostat fault.	• Disconnect thermostat from controller, turn thermostat to maximum setting, and check continuity.
	• Internal control fault.	• With thermostat disconnected from terminal block, voltmeter should read 24V (AC) across terminals HT and R.
No heat when called by thermostat and stage indicators are displayed on LCD screen.	• Main fuses blown (if applicable).	• Check main fuses and replace if blown.
	• Internal control fault.	• Display stage indicator by adjusting thermostat to maximum setting and check for 24V (AC) across stages 1, 2, and 3.
	• Main contactor(s) fault.	• Check each contactor coil's terminals for a supplied voltage of 24V (AC). If present, main contactor(s) are faulty and must be replaced. If not present, wiring continuity fault exists – check and repair.



PROBLEM	CAUSE	SOLUTION / CHECK
	<ul style="list-style-type: none"> Flow Switch is open 	<ul style="list-style-type: none"> Check for closed circuit between FS-5 and FS-6 and 24V (AC) across FS-6 and C-1.
	<ul style="list-style-type: none"> Element fault. 	<p>RISK OF ELECTROCUTION! – MAIN POWER TO ELEMENTS MUST BE DISCONNECTED! Next, disconnect element wires from main contactor(s) and check for continuity. If no continuity, replace element. If continuity, the contactor is defective. (To confirm contactor defect, check for continuity across main contactor when closed.)</p>
Pump runs constantly when there is no call for heat.	<ul style="list-style-type: none"> Internal control fault. 	<ul style="list-style-type: none"> Replace controller.
Pump will not run.	<ul style="list-style-type: none"> Pump ceased or burnt out. 	<ul style="list-style-type: none"> Repair or replace.
	<ul style="list-style-type: none"> Pump wiring fault. 	<ul style="list-style-type: none"> Check and repair wiring.
	<ul style="list-style-type: none"> Pump fuse blown. 	<ul style="list-style-type: none"> Check pump fuse and replace if necessary.
	<ul style="list-style-type: none"> Internal control fault. 	<ul style="list-style-type: none"> Replace controller.
Controller does not operate normally.	<ul style="list-style-type: none"> Internal control fault. 	<ul style="list-style-type: none"> Replace controller.
Pressure relief valve discharges water.	<ul style="list-style-type: none"> Relief valve not reseating properly. 	<ul style="list-style-type: none"> Quickly lift and release manual discharge lever on relief valve to assist proper reseating. If this fails, replace pressure relief valve.
	<ul style="list-style-type: none"> Pressure reducing valve set too high. 	<ul style="list-style-type: none"> Reduce setting of pressure reducing valve.
Water leaking from electric boiler.	<ul style="list-style-type: none"> Element or sensor threads leaking. 	<ul style="list-style-type: none"> Turn off all electricity to the boiler. Remove wires from element terminals and tighten elements (with correct socket wrench). Turn off water, drain, remove and apply sealant if necessary.
	<ul style="list-style-type: none"> Plumbing connections leaking. 	<ul style="list-style-type: none"> Tighten incoming pipes and pressure relief valve. Turn off water, drain and remove and apply sealant if necessary. (Be sure to turn off electricity before draining or elements will burn out.)

7.2 SENSOR CHECK

1. **SHUT OFF MAIN POWER TO THE ELEMENT HEATING CIRCUIT BEFORE TROUBLESHOOTING!**
2. Confirm correct sensor wiring. Refer to the wiring diagram sticker on the back of the boiler front casing panel.
3. Make sure there is no power applied to the controller before measuring resistance.
4. To test for a defective sensor, measure the resistance directly at the sensor location. The resistance should be roughly 12000 ohms at room temperature (68°F). For other temperatures and their corresponding resistance readings, refer to the *BC-1 Controller Manual*.
5. If the meter reads a very high resistance, there may be a broken wire, a poor wiring connection or a defective sensor. If the resistance is very low, the wiring may be shorted, there may be moisture in the sensor or the sensor may be defective.



Replacement Parts **Section 8**

8.1 ORDERING

Replacement parts or a replacement electric boiler may be purchased through any Allied Engineering Company distributor – call us if you need help locating a distributor near your area. If you require any technical assistance or have any comments about our product, please write or phone us at:

Service Department
 Allied Engineering Company
 94 Riverside Drive
 North Vancouver, B.C. CANADA
 V7H 2M6
 Tel (604) 929-1214 Fax (604) 929-5184
 Email: sales@alliedboilers.com

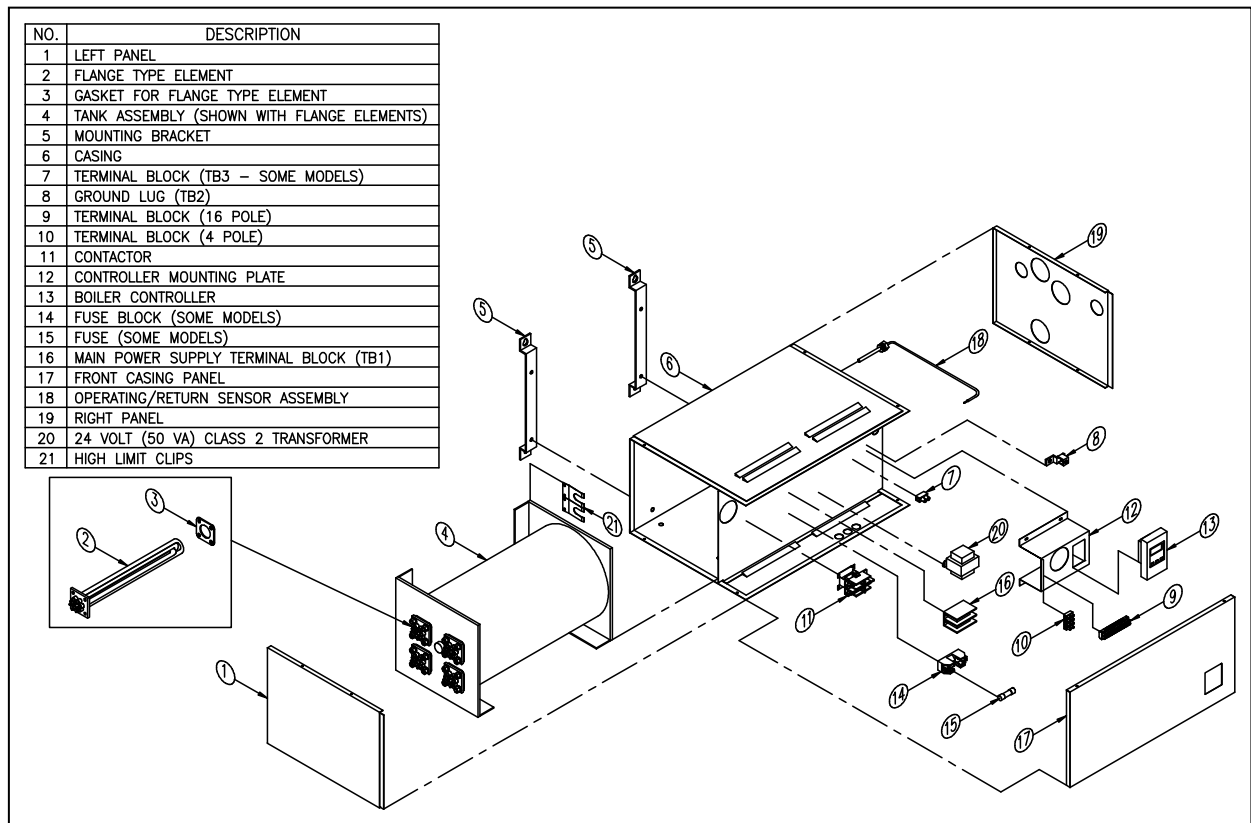

Figure 8 – Replacement Parts



Notes

Section 9



Index	Section 10
--------------	-------------------

Section		Page
1.0	Dimensions and Specifications	
1.1	Technical Specifications.....	2
1.2	Water Temperature Rise vs Flow Rate.....	3
1.3	General Dimensions.....	3
2.0	Installation Instructions	
2.1	Receiving.....	4
2.2	Introduction.....	4
2.3	Boiler Location.....	4
2.4	Wall mounting	5
2.5	Piping	5
2.6	System Operating Requirements	6
3.0	Wiring	
3.1	Electrical Wiring	7
4.0	Startup Instructions	
4.1	Warning.....	9
4.2	Startup.....	9
5.0	BC-1 Controller Information	
5.1	Controller Information.....	10
5.2	Controller Display	11
5.3	Controller Operation	13
5.4	Reset Override	13
5.5	Controller Mounting.....	14
6.0	Maintenance Instructions	
6.1	Service Hints	15
7.0	Troubleshooting Guide	
7.1	Troubleshooting.....	16
7.2	Sensor Check.....	17
8.0	Replacement Parts	
8.1	Ordering	18
9.0	Notes	19
10.0	Index	20